

Project	IEEE 802.16 Broadband Wireless Access Working Group < http://ieee802.org/16 >	
Title	Clarifications on Cooperative Relaying	
Data	2007-05-09	
Submitted		
Source(s)	Jimmy Chui, Aik Chindapol Siemens Corporate Research 755 College Road East Princeton, NJ, USA	Voice: +1 609 734 3364 Fax: +1 609 734 6565 aik.chindapol@siemens.com
	Kyu Ha Lee, Young-Jae Kim, Changkyoon Kim Samsung Thales San 14, Nongseo-Dong, Giheung-Gu, Yongin, Gyeonggi-Do, Korea 449-712	Voice: +82-31-280-9917 Fax: +82-31-280-1562 kyuha.lee@samsung.com
	Byung-Jae Kwak, Sungcheol Chang, D. H. Ahn, Young-il Kim ETRI 161, Gajeong-Dong, Yuseong-Gu, Daejeon, Korea 305-350	Voice: +82-42-860-6618 Fax: +82-42-861-1966 bjkwak@etri.re.kr
	Chungyong Lee, Byungwook Yoo Yonsei University 134 Sinchon-dong Seodaemun-gu, Seoul, Korea 120-749	Voice: +82-2-2123-7740 Fax: +82-2-312-4584 clee@csp.yonsei.ac.kr
	Peter Wang, Adrian Boariu, Shashikant Maheshwari, Yousuf Saifullah Nokia 6000 Connection Drive, Irving, TX	Voice: +1 214-912-4613 peter.wang@nokia.com
Re:	Call for technical comments and contributions regarding IEEE Project P802.16j.	
Abstract	The document contains technical proposals for IEEE P802.16j that provides cooperative diversity in relay downlink.	
Purpose	This is a response to Call for technical comments and contributions regarding IEEE Project P802.16j.	
Notice	This document has been prepared to assist IEEE 802.16. It is offered as a basis for discussion and is not binding on the contributing individual(s) or organization(s). The material in this document is subject to change in form and content after further study. The contributor(s) reserve(s) the right to add, amend or withdraw material contained herein.	

Release The contributor grants a free, irrevocable license to the IEEE to incorporate material contained in this contribution, and any modifications thereof, in the creation of an IEEE Standards publication; to copyright in the IEEE's name any IEEE Standards publication even though it may include portions of this contribution; and at the IEEE's sole discretion to permit others to reproduce in whole or in part the resulting IEEE Standards publication. The contributor also acknowledges and accepts that this contribution may be made public by IEEE 802.16

Patent Policy and Procedures The contributor is familiar with the IEEE 802.16 Patent Policy and Procedures <<http://ieee802.org/16/ipr/patents/policy.html>>, including the statement "IEEE standards may include the known use of patent(s), including patent applications, provided the IEEE receives assurance from the patent holder or applicant with respect to patents essential for compliance with both mandatory and optional portions of the standard. "Early disclosure to the Working Group of patent information that might be relevant to the standard is essential to reduce the possibility for delays in the development process and increase the likelihood that the draft publication will be approved for publication. Please notify the Chair <<mailto:chiar@wirelessman.org>> as early as possible, in written or electronic form, if patented technology (or technology under patent application) might be incorporated into a draft standard being developed within the IEEE 802.16 Working Group. The Chair will disclose this notification via the IEEE 802.16 web site <<http://ieee802.org/16/ipr/patents/notices>>.

Cooperative Relaying in Downlink for IEEE 802.16j

1 Introduction

In general, a single time-frequency resource within a frame is assigned to one RS in relay downlink to MS as shown in figure 1. While a relay station is transmitting a packet, other stations do not transmit using the same time-frequency resource. However, a MS may experience improved decoding performance if it receives the same information from multiple sources. In cooperative relay (which we also call cooperative transmission), by allowing a set of multiple signal sources to transmit correlated data using the same time-frequency resource (where the set of signal sources may be composed of a combination of RSs and MMR-BS), we can achieve cooperative diversity gain to improve the performance of the relay network. This diversity gain can be accomplished in 3 ways: cooperative source diversity, where the same signal is transmitted from different sources; cooperative transmit diversity, where the signal is space-time coded and transmitted from different sources; and cooperative hybrid diversity, which is a hybrid mixture of source and transmit diversity.

Cooperative transmission is also an effective method to combat the pilot collision problem. Pilot collision, which is referred to the mismatch between channel estimation and true data channel response at MSs overhearing pilot signals from multiple stations, is a special problem after the introduction of RS in the mobile multihop networks [4][5]. This problem is alleviated regardless of the diversity scheme used.

Therefore, the cooperative transmission techniques, processing abilities to achieve diversity gain and to effectively combat pilot collision, are very promising for IEEE 802.16j network.

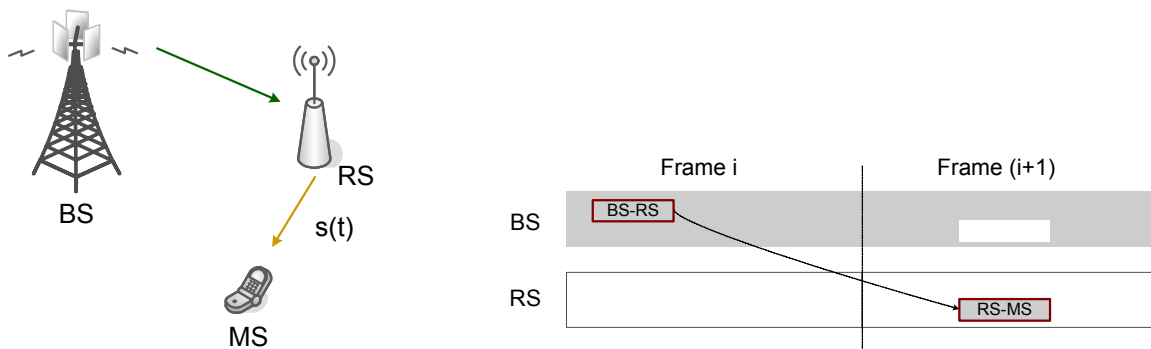

Figure 1. Example of general relay transmission¹

The concept of virtual MIMO has been discussed in previous contributions such as [3]. Virtual MIMO can achieve the following advantages:

- Low complexity and ease of implementation
- Reuse of existing techniques in legacy standard
- Increase in performance (diversity) without sacrificing bandwidth

The following must be ensured:

¹ Here, different frame relay, i.e. RS receives packet of MS in frame i and transmits the packet to MS in frame $i+1$, is used as an example. However, the following proposed techniques can not only be used in different frame relay but also in the same frame relay.

- Synchronization between cooperating signal sources is imperative to prevent ISI
- Received power should be strong/balanced for all cooperating signal sources directed to a particular MS
- If STBCs are used, the MS must support STBC decoding (optional in the 802.16e standard).

2 Proposed Solution

We propose three cooperative relay schemes:

- Cooperative source diversity: Multiple signal sources simultaneously transmit the *same* signal using the same time-frequency resource.
- Cooperative transmit diversity: Multiple signal sources simultaneously transmit *space-time encoded* signals using the same time-frequency resource.
- Cooperative hybrid diversity: A combined diversity scheme of the cooperative source and cooperative transmit diversity.

We first demonstrate the use of these diversity mechanisms using the Alamouti code as a base example (if applicable). Section 2.4 describes how other codes may be used.

2.1 Cooperative source diversity

Figure 2 shows examples of cooperative source diversity. In figure 2(a), diversity gain will be obtained by combining the relay transmission from the RS and the transmission from the MMR-BS transmitted using the same time-frequency resource. Figure 2(b) illustrates a source diversity scheme, where multiple RSs transmitting at the same time using the same time-frequency resource. Figure 2(c) describes an example of cooperative source diversity, where signals from two RSs and an MMR-BS are combined. Figure 3 shows the simulation results of BER performance for the example shown in Fig. 2(a). In the simulation, we assumed that the signals arriving at the MS are of the same power, and that the SNR on the relay link is 30 dB. The channel model used in the simulation was SUI-4 model. The signal was transmitted using QPSK modulation with 1/2 convolution code. The same simulation environment was assumed for all simulations in this document.

If the transmission timing differences from multiple signal sources are within a CP period, an OFDMA system, which is robust in multipath channel environment, can take advantage of the signal arrivals from multiple sources to obtain diversity gain.

To see how pilot collisions can be mitigated, consider Fig.2(a). If the MS can receive signals from both RS and BS (assuming the channel response from BS to MS is $H_1(k)$ and from RS to MS is $H_2(k)$, where k is the subcarrier index), it will hear a superposed pilot signals (one from RS and the other from BS) in the pilot subchannel and will estimate a "summed" channel response, i.e. $H_1(k)+H_2(k)$. However, the true channel response of data subchannel of MS is $H_2(k)$. Therefore, the performance of MS will be greatly degraded by using the wrong channel response for data detection. Through BS and RS cooperatively transmitting pilots and data of MS at the same time on the same resource, the pilot collision problem can be solved because MS receives not only the "collided" pilots but also the "collided" data. Therefore, MS can perform the correct detection without any modifications [5].

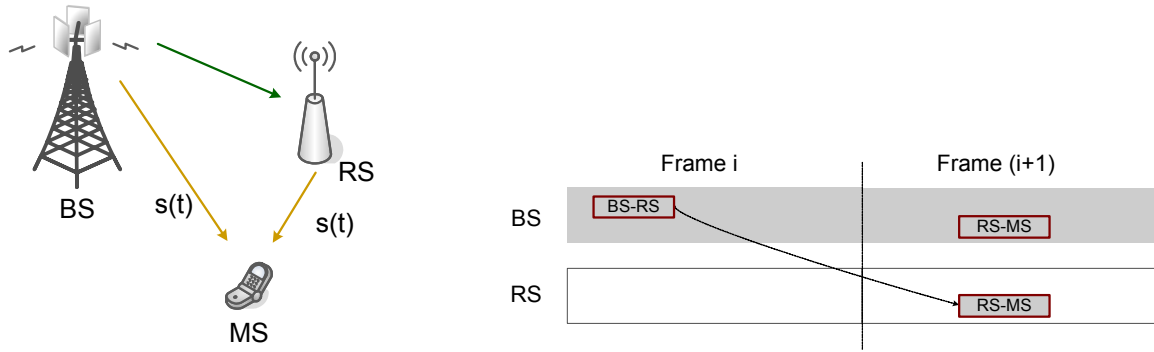

(a) Usage of BS and RS transmit source

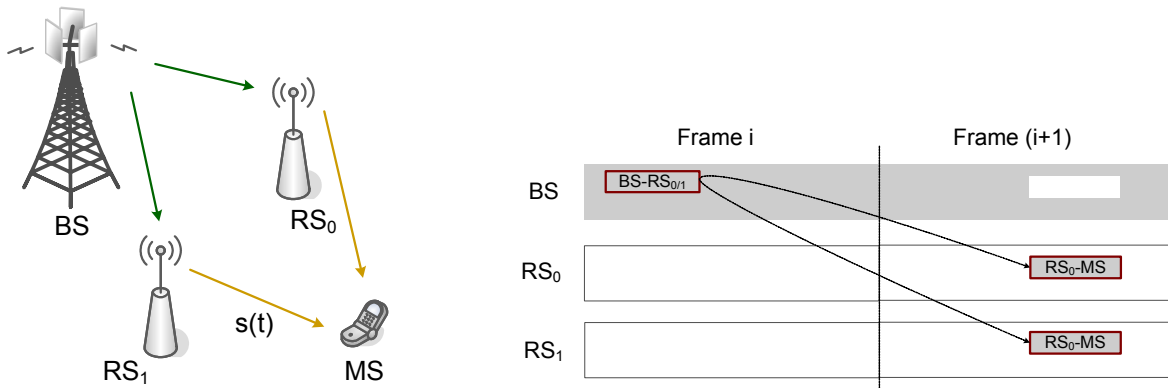

(b) Usage of multiple transmit source of RSs

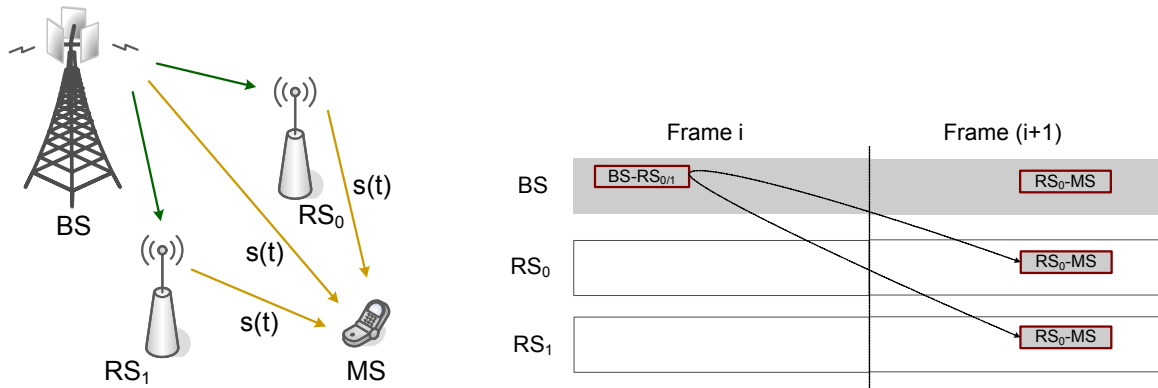

(c) Usage of multiple transmit source of BS and RSs

Figure 2. Example of cooperative source diversity

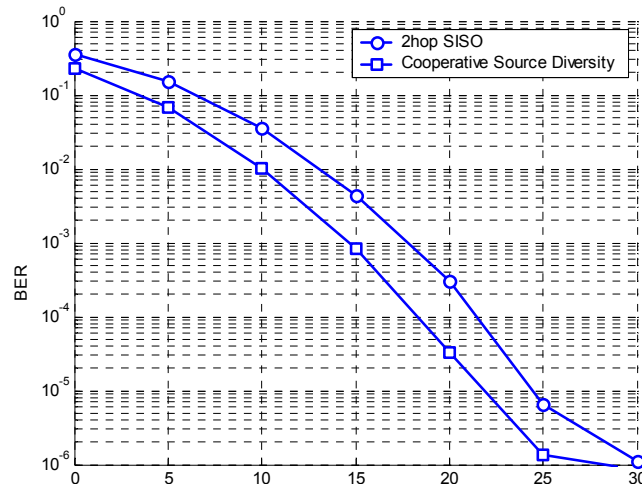

Figure 3. Simulation result of Figure 3(a).

Assumptions: 1. Received signal powers from sources are same.
2. SNR of BS-RS is 30dB

2.2 Cooperative transmit diversity

This method uses space-time block codes across different physical signal sources. For rate 1 codes, using existing modulation methods, there is no increase in backhaul communication compared with standard relaying techniques. By implementing STBCs across different physical transmitting stations, it is possible to achieve diversity.

This proposed method is based on the use of transmit diversity using STBCs. The transmit structures of the cooperative transmit diversity and the cooperative source diversity are identical. However, in the cooperative transmit diversity scheme, the received signals from different sources are different, each signal source playing the role of different transmit antenna in the conventional STBC. If the STBC encoding is performed at the MMR-BS, the RSs simply need to relay the packets. However, if the STBC encoding is performed at the RSs, the channel utilization will be more efficient because the MMR-BS needs to transmit the packet only once in the example illustrated in Fig. 4(d). Figure 5 shows the simulation results of the BER performance of the examples shown in Fig. 4(a) and (b). These examples use rate-1 codes for two transmit antennas (Code A in Sections 8.4.8.1.4, 8.4.8.3.3 in the standard [1,2]).

RS performs localized STC encoding, which we call Cooperative STC Encoding. The RS shall take incoming data from the BS and perform STC encoding as specified by the antenna assignment and STC in use. The STC encoding is done locally at the RS. The MR-BS does not alter data during the transmission on the relay link.

In cooperative transmit diversity this mode, pilot collisions are not a problem because the transmit antennas (at the BS and RS, or at two RSs) are acting as different antennas of a STBC. The pilots are thus transmitted on a per-antenna basis, and hence do not collide.

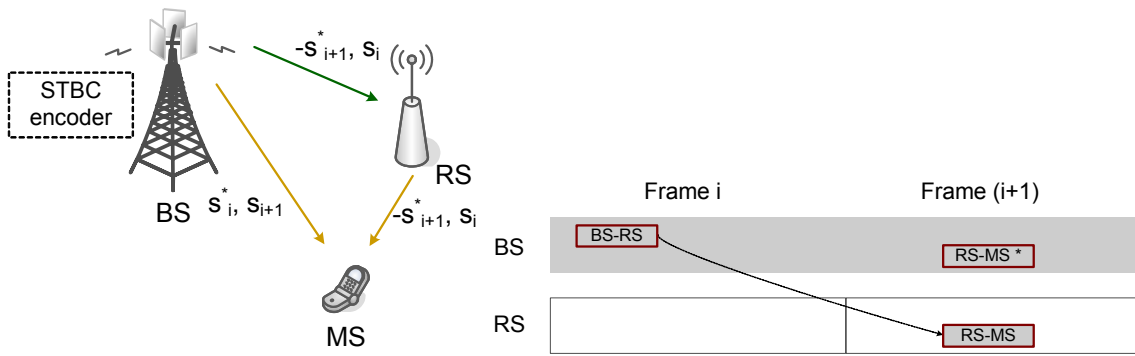

(a) Usage of BS and RS transmit source – full encoding in BS

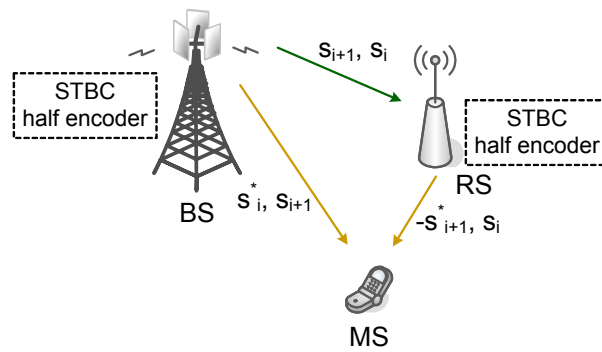

(b) Usage of BS and RS transmit source – partial encoding in BS and RS

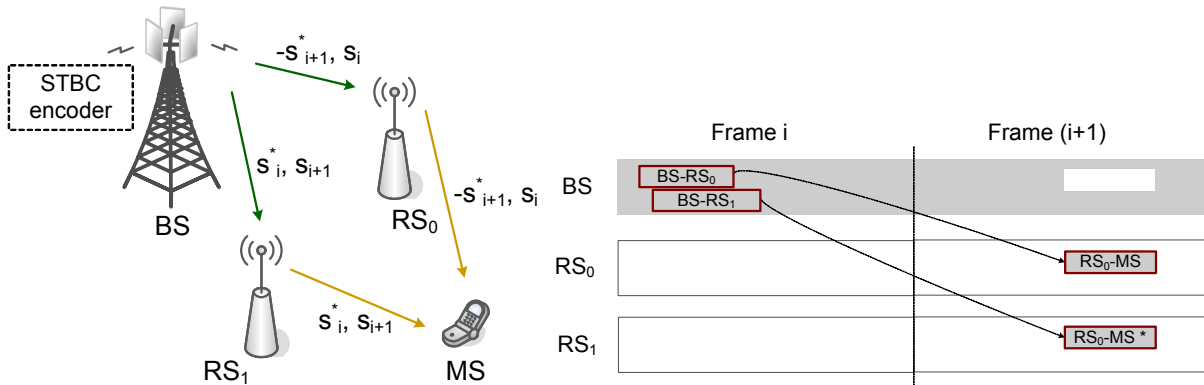

(c) Usage of multiple transmit source of RSs – full encoding in BS

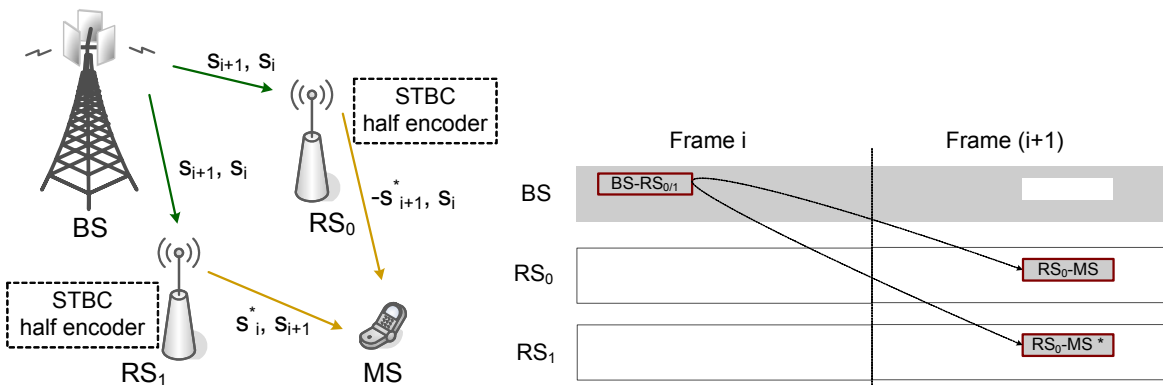

(d) Usage of multiple transmit source of RSs – partial encoding in BS and RS

Figure 4. Examples of cooperative transmit diversity

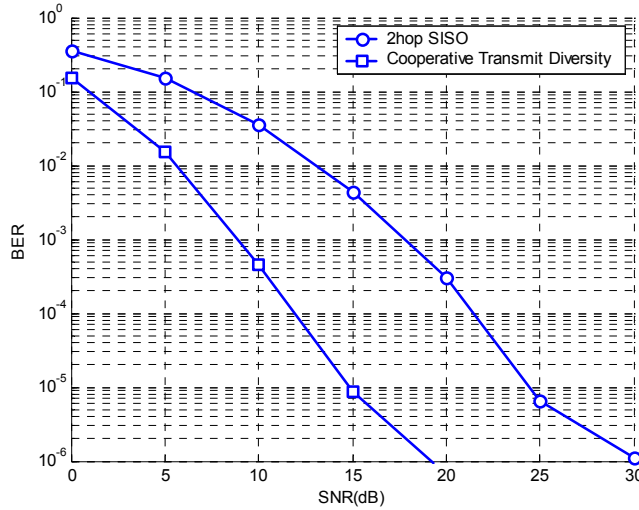

Figure 5. Simulation result of Figure 5(a)(b).

- Assumptions: 1. Received signal powers from sources are same.
- 2. SNR of BS-RS is 30dB

2.3 Cooperative hybrid diversity

In case of multiple signal sources, the two cooperative relaying schemes can be combined. If the number of signal sources are greater than the number M in a $M \times 1$ STBC scheme, multiple signal sources can transmit the same STBC encoded signal to implement an $M \times 1$ STBC scheme. Figure 6 shows an example of this hybrid cooperative source and transmit diversity scheme, where three signal sources are cooperating to perform rate-1 space-time coding with two transmit antennas. Figure 7 shows the simulation results of the BER performance of the examples shown in Fig. 6.

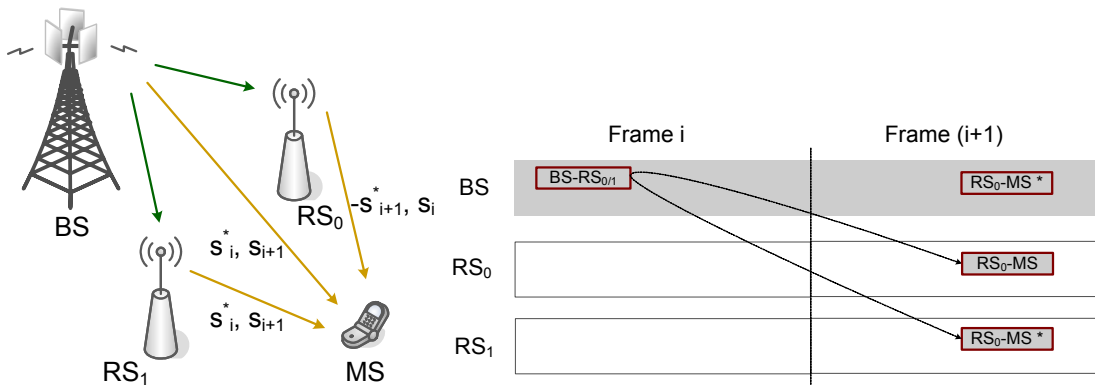

Figure 6. Example of cooperative joint-hybrid diversity

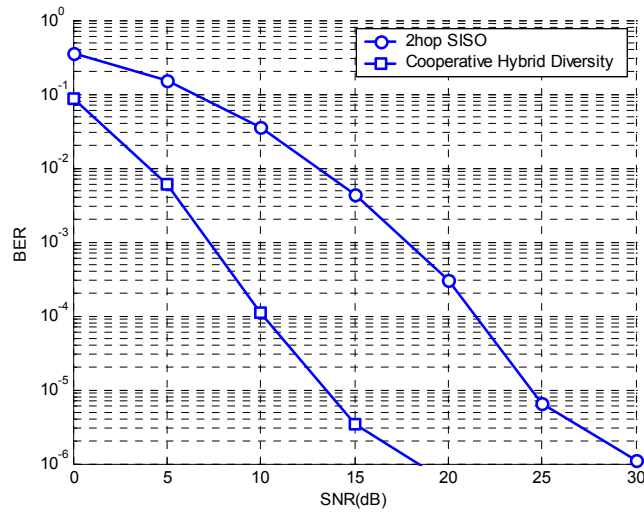

Figure 7. Simulation result of Figure 6.

- Assumptions: 1. Received signal powers from sources are same.
- 2. SNR of BS-RS is 30dB

2.4 Use of other space-time codes

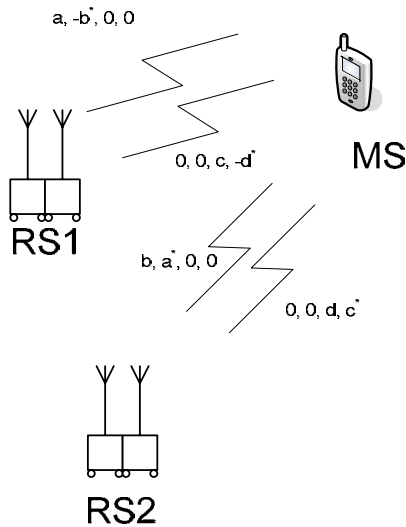

Figure 8. Example of cooperative relaying using rate-1 code for four transmit antennas.

The previous examples use the Rate-1 transmit diversity codes for two transmit antennas (the Alamouti code). It is possible to use other rate-1 codes, such Code A in Sections 8.4.8.2.3, 8.4.8.3.5 in the standard [1,2]. This can be used in cells with four single-antenna transmitters, or two dual-antenna transmitters, for example. For this particular code, only two transmit antennas

are on at any given time. This contribution proposes to have these active antennas in separate locations. Since a rate-1 code is used, the resources for the backhaul does not increase if compared to the standard relaying mechanism. Multiple RSs can listen to these transmit antennas during the backhaul.

It is possible to use other, higher-rate codes. However, there is a tradeoff between the resources required for the backhaul links, the rate achieved by the forward link to the MS, and the performance (packet error rate) of these links.

3. Text Proposals

[change subclause 6.3.2.3.62 as follows]

6.3.2.3.62 Cooperative diversity configuration for RS (RS-CDC) message

An RS-CDC is sent by a MR-BS to an RS to configure the cooperative diversity mode.

Table 109z—RS-CDC message format

Syntax	Size	Notes
RS-CDC_Message_Format() {		
Management Message Type=67?	8 bits	
Antenna Assignment	4 bits	Bit#0: Antenna #0 Bit#1: Antenna #1 Bit#2: Antenna #2 Bit#3: Antenna #3
RS Encoding Method	1 bit	0b0 = No encoding 0b1 = Encoding
Reserved	43 bits	Reserved shall be set to zero
}		

An MR-BS shall generate RS-CDC message in the form shown in Table 109z. These parameters shall be effective in STC DL zones where STC is not '0b00' in the corresponding STC_DL_Zone_IE, including the following parameters:

Antenna Assignment

Indicates which antenna the corresponding RS should play the role of. For example, if this field is a 0b1000, the relay station shall be playing the role of Antenna #0. As another example, in case the RS has two antennas and this field is 0b1100, each antenna two antennas of the RS shall be playing take the roles of Antenna #0 and #1, respectively. Each antenna will transmit pilots based on the permutation, number of antennas as indicated in STC_DL_Zone_IE, and antenna assignment according to Figure 245, 247, 251, 251a, based on the chosen STC in the corresponding STC_DL_Zone_IE. The MR-BS shall indicate the effective number of antennas being used for cooperative relaying.

~~If no transmit diversity is used (STC='0b00' in STC_DL_Zone_IE), all active antennas use non-STC pilot patterns.~~

RS Encoding method

~~No Encoding indicates that the relay station retransmits the data symbols, in order, without modification. Note that the pilot transmission must still be obeyed, according to the antenna assignment and STC.~~

~~Encoding indicates that the symbols [S1, S2], or [S1, S2, S3, S4], or [S1, S2, S3, S4, S5, S6, S7, S8] are transmitted by the BS and received by the RS, in that order, and re-encoded by the RS according to the chosen STC defined in 8.4.8.1.4 and 8.4.8.2.3. The STC is based on the parameters in the corresponding STC_DL_Zone IE.~~

~~For 2 transmit antennas using Matrix A, Encoding follows the coding scheme for code A in 8.4.8.1.4. That is, it represents the operation [S1 S2] → [S1 S2*] for Antenna #0, [S2 S1*] for Antenna #1.~~

~~For 4 transmit antennas using Matrix A, Encoding follows the coding scheme for code A in 8.4.8.2.3. That is, it represents the operation [S1 S2 S3 S4] → [S1 S2* 0 0] for Antenna #0, [S2 S1* 0 0] for Antenna #1, [0 0 S3 S4*] for Antenna #2, [0 0 S4 S3*] for Antenna #3.~~

~~For 2 transmit antennas using Matrix B, Encoding follows the coding scheme for code B in 8.4.8.1.4. This is a mapping from two symbols to one symbol, i.e. [S1 S2] → [S1], [S2] for Antenna #0, #1 respectively.~~

~~For 4 transmit antennas using Matrix B, Encoding follows the coding scheme for code B in 8.4.8.2.3. This is a mapping from eight symbols to four symbols.~~

~~For 4 transmit antennas using Matrix C, Encoding follows the coding scheme for code C in 8.4.8.2.3. This is a mapping from four symbols to one symbol.~~

In a STC_DL_Zone where STC is not '0b00', the RS shall take data from the BS and perform local STC encoding as specified by its antenna assignment(s) and STC Matrix in use as defined by STC_DL_Zone_IE, MIMO DL Basic IE, or MIMO DL Enhanced IE.

[Change subclause 8.4.8.10 as follows]

8.4.8.10 Cooperative Relaying

Cooperative relaying can be achieved within an MR-BS cell with MS-BS and RS transmit cooperation, ~~in the same manner as macro diversity with neighboring BS.~~ For non-transparent relays, the macro diversity procedure can be used. It is possible to achieve diversity ~~and solve the pilot collision problem~~ by sending correlated signals across different MR-BS and RS transmit antennas during the transmission of a burst to a particular MS subordinate stations. The three modes of operation for cooperative relaying are cooperative source diversity, cooperative transmit diversity, and cooperative hybrid diversity.

There are three modes for cooperative relaying. In the following description, the transmission considered is the final hop from the multiple antennas at the BS/RS to the MS. For cooperative source diversity, the transmitting antennas simultaneously transmit the same signal using the same time-frequency resource. ~~The~~ In cooperative transmit diversity mode, STC-encoded signals are transmitted mechanism uses STBC encoded signals across the transmitting antennas using the same time-frequency resource (refer to Section 8.4.8 for a list of valid STBCs). Cooperative hybrid diversity is uses a combination of source and transmit diversity.

In a STC DL Zone with STC not set to '0b00', the RS shall perform STC encoding locally by using the STC Matrix as defined by STC_DL_Zone_IE (or MIMO DL Basic IE or MIMO DL Enhanced IE) for its assigned antenna number(s) as indicated in RS-CDC, and shall not forward an incorrectly decoded burst to its subordinate stations. Figure ZZZ is an example of local STC encoding at the RS.

In cooperative relaying, the frames sent by MR-BS and RS at a given frame time must arrive at the MS within the prefix interval, similar to MDHO.

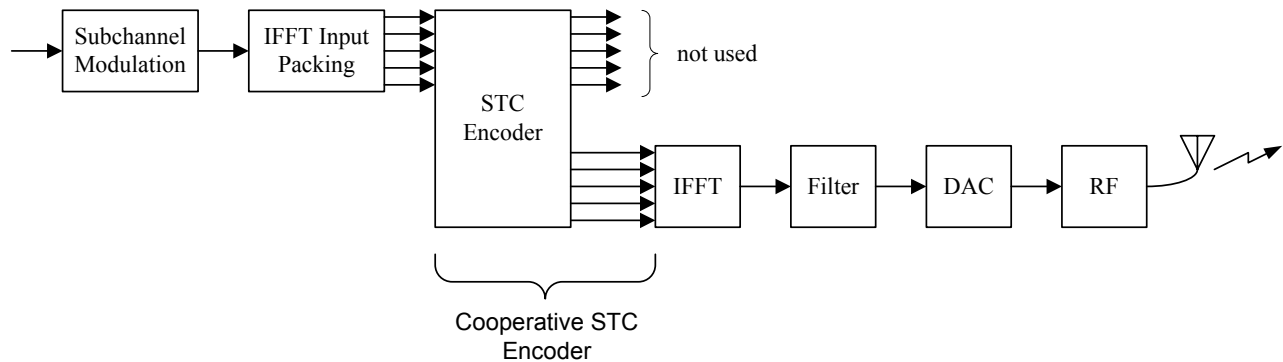

Figure ZZZ. A logical block example of local STC Encoding at RS. The STC Encoder is identical to the encoder in Figure 244 of Section 8.4.8.1.

~~These mechanisms can each be further subdivided into two categories describing the processing requirement at the RS. The relayed data at the RS may not require processing, which we have called Full Encoding (i.e. during the backhaul hop, the BS transmits the exact signals for the RS to relay). Alternately, the relayed data at the RS may require some local processing, which we have called Half Encoding (the backhaul hop contains uncoded data, and the RS decodes and re-encodes the data according to the STBC in use). In this last category, each RS shall be notified of its virtual antenna number(s).~~

4. References

- [1] IEEE 802.16-2004, "Part 16: Air Interface for Fixed and Mobile Broadband Wireless Access Systems".
- [2] IEEE 802.16e-2005, "Part 16: Air Interface for Fixed and Mobile Broadband Wireless Access Systems, Amendment 2: Physical and Medium Access Control Layers for Combined Fixed and Mobile Operation in Licensed Bands and Corrigendum 1".
- [3] IEEE C802.16j-06/006r1, "Cooperative Relay in IEEE 802.16j MMR".
- [4] IEEE C802.16j-05_019, "PHY aspects in MMR-enabled networks".
- [5] IEEE C802.16j-06/230r2, "Efficient resource utilization scheme on the basis of precoding and cooperative transmission in downlink".