

Project	IEEE 802.16 Broadband Wireless Access Working Group < http://ieee802.org/16 >
Title	An Framework for Multi-hop Path Management MMR Networks
Date Submitted	2006-09-24
Source(s)	Erwu Liu, Dongyao Wang, Jimin Liu, Voice: 86-21-50551240-8194 Gang Shen, Niwei, Shan Jin Fax: 96-21-50554554 Alcatel Shanghai Bell, { Erwu.liu , Dongyao.Wang , Gang.A.Shen , Ni.We , No.388, Ningqiao Road, Shanghai, Shan.Jin } P.R.C. @ alcatel-sbell.com.cn Torsten Fahldieck torsten.fahldieck@alcatel.de Alcatel SEL AG Holderaeckerstr.35, Stuttgart, Germany
Re:	IEEE 802.16e-2005
Abstract	Define path management framework
Purpose	For text changes in emerging amendment of IEEE 802.16e-2005 to support MMR functionality.
Notice	This document has been prepared to assist IEEE 802.16. It is offered as a basis for discussion and is not binding on the contributing individual(s) or organization(s). The material in this document is subject to change in form and content after further study. The contributor(s) reserve(s) the right to add, amend or withdraw material contained herein.
Release	The contributor grants a free, irrevocable license to the IEEE to incorporate material contained in this contribution, and any modifications thereof, in the creation of an IEEE Standards publication; to copyright in the IEEE's name any IEEE Standards publication even though it may include portions of this contribution; and at the IEEE's sole discretion to permit others to reproduce in whole or in part the resulting IEEE Standards publication. The contributor also acknowledges and accepts that this contribution may be made public by IEEE 802.16.
Patent Policy and Procedures	The contributor is familiar with the IEEE 802.16 Patent Policy and Procedures < http://ieee802.org/16/ipr/patents/policy.html >, including the statement "IEEE standards may include the known use of patent(s), including patent applications, provided the IEEE receives assurance from the patent holder or applicant with respect to patents essential for compliance with both mandatory and optional portions of the standard." Early disclosure to the Working Group of patent information that might be relevant to the standard is essential to reduce the possibility for delays in the development process and increase the likelihood that the draft publication will be approved for publication. Please notify the Chair < mailto:chair@wirelessman.org > as early as possible, in written or electronic form, if patented technology (or technology under patent application) might be incorporated into a draft standard being developed within the IEEE 802.16 Working Group. The Chair will disclose this notification via the IEEE 802.16 web site < http://ieee802.org/16/ipr/patents/notices >.

Multi-hop Path Management

Framework in MMR Networks

Erwu Liu, Dongyao Wang, Jimin Liu, Gang Shen, Ni Wei, Shan Jin

Alcatel Shanghai Bell. Inc.

1 Introduction

This document is to describe path management framework as an input for call for contribution of 802.16j task group. Path management is a mandatory technical requirement, as defined in IEEE C802.16j-06_017 contribution [1].

In MMR-enable networks, one or several RSs are introduced to improve capacity or enhance coverage. A mechanism is needed to manage path(s) for the communications between MS and MR-BS via RSs in such networks.

In this document, we propose a very flexible framework together with corresponding messages and procedures to support the path management (path setup/change/delete). The framework shall facilitate QoS provision, multi-path routing and data/control plane separation in MMR networks and be fully compatible with 802.16 on the access link. Furthermore, the implementation complexity on RS under the framework should be low.

2 Path Management Framework

In 802.16 networks, connection management is via a 3-way hand-shaking procedure (DSX-REQ, DSX-RSP, DSX-ACK), and the connection management can be initiated by MS or BS. In the following sections, we assume MS-initiated connection management for the discussion. Similar procedure applies to the BS-initiated connection management.

As shown in figure 1, in this document, path for a particular MAC PDU that is sent via CID C0 on the logical access link is defined as the sequence of CIDs <C1, C2, ..., Cn>:

1. For all $i, 1 \leq i \leq n$, C_i is the CID allocated to identify the logical relay link L_i .
2. For all $i, 1 \leq i \leq n-1$, C_i and C_{i+1} can use same or different CID.
3. Different CIDs can be used to identify same logical relay link.

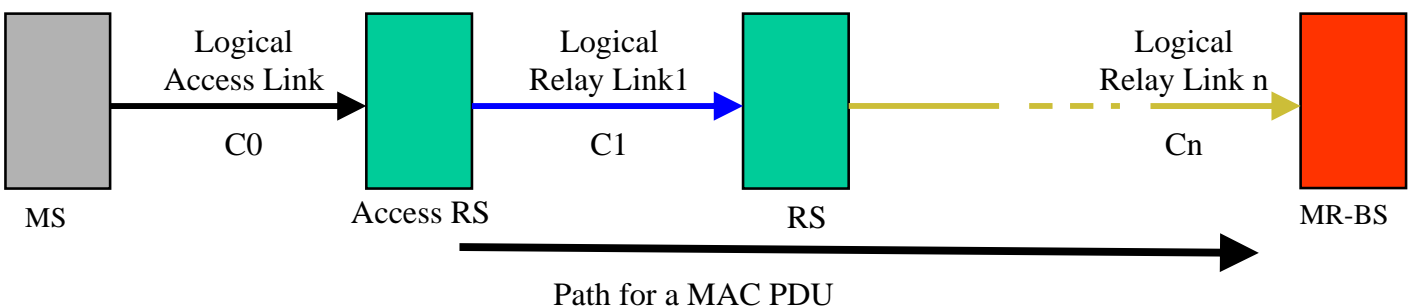

Fig.1 Path, Logical Relay Link and Connection

In MMR, path could be managed in MR-BS in centralized manner, or be distributed but coordinated by MR-BS. In centralized approach, MR-BS collects various statistics such as link quality, link bandwidth to manage paths.

By using proposed CID mapping mechanism, this document presents a framework for path setup, change and delete.

2.1 CID Mapping--Outline

In this proposal, relay station in MMR should maintain a CID forwarding table. The CID forwarding table tells what actions to take to relay an incoming MAC PDU. MR-BS in MMR should maintain a routing table. In centralized mode, for each service, the MR-BS should maintain path(s) for it and generate CID mapping information to the relay stations on the path(s). On receiving CID mapping information, the relay stations should update their CID forwarding table.

Table 1 is an illustrated example of the CID forwarding table in a relay station.

Ingress CID	Outgress CID	Action
20	30	Encap
100	105	De-cap
500	300	Translate

Table.1 CID Forwarding Table Example.

In table.1, the encap action means to add an outgress CID on top of the ingress CID in the header of the MAC PDU, the de-cap action means to extract the ingress CID then do CID translate action, the translate action means to replace the ingress CID with an outgress CID. Indeed, translate action is the most common one for a relay station to relay service.

For the framework to be more flexible, the CID Mapping would allow 1:1, M:1, 1:N and M:N CID mapping.

Figure 2 depicts the case that different service undergoes different path. Indeed, relay station in figure 2 uses 1:1 CID mapping where one ingress connection is mapped onto one outgress connection.

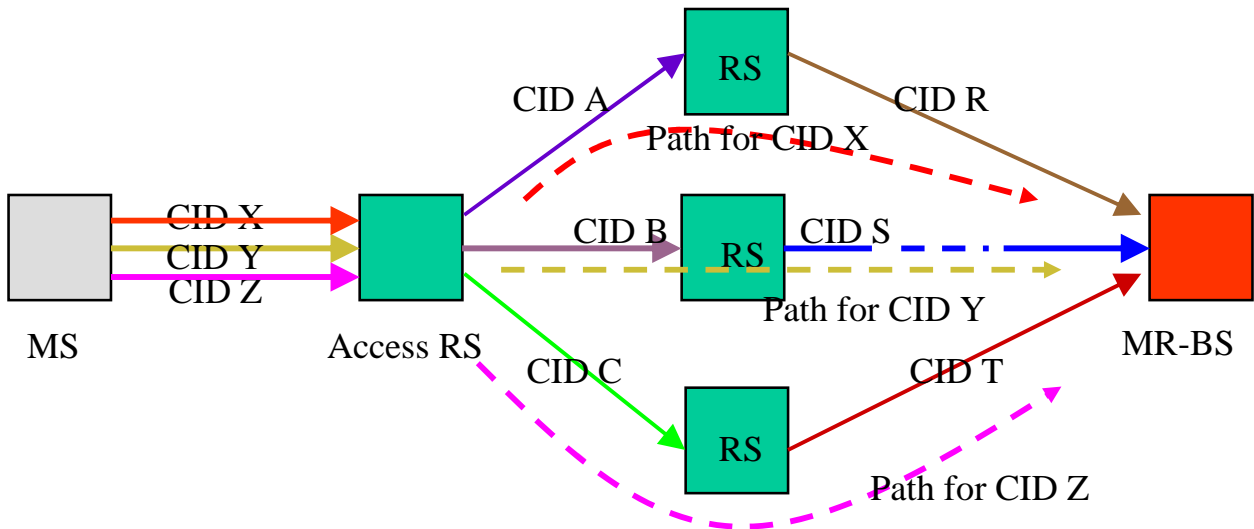

Fig.2 One path per service

Figure 3 depicts the case that multiple services are merged into one path. Indeed, access RS in figure 3 uses M:1 CID mapping where multiple ingress connections are merged onto one outgress connection. M:1 CID mapping may introduce ARQ/HARQ issue as the MAC PDU from CID W/XY/Z would need to be retransmitted on CID

A even if only MAC PDU from CID W is error on CID A (802.16 requires that ARQ/HARQ be done per connection)

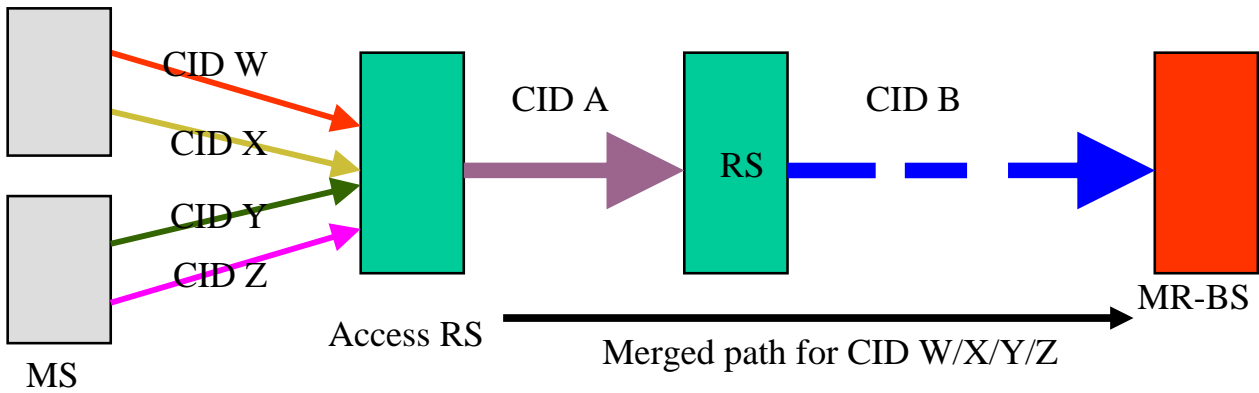

Fig.3 Multiple service per path

To summarize a typical path setup procedure

1. MS requests a service connection via DSA-REQ message
2. Relay stations relay the message to MR-BS, typically,
 - a) Access RS takes encaps action to relay the DSA-REQ message
 - b) Intermediate RS takes translate action to relay the DSA-REQ message
3. MR-BS allocates CID for the service and chooses a path for it, and associate CID mapping information (i.e., information that tells relay stations on the path what CID(s) and action(s) to relay the service) with the route. MR-BS then notifies relay stations on the path of the CID mapping information for the service. The CID mapping information can be piggybacked in DSA-RSP message, or sent standalone.
 - a) CID mapping information piggyback. Refer to figure 4.

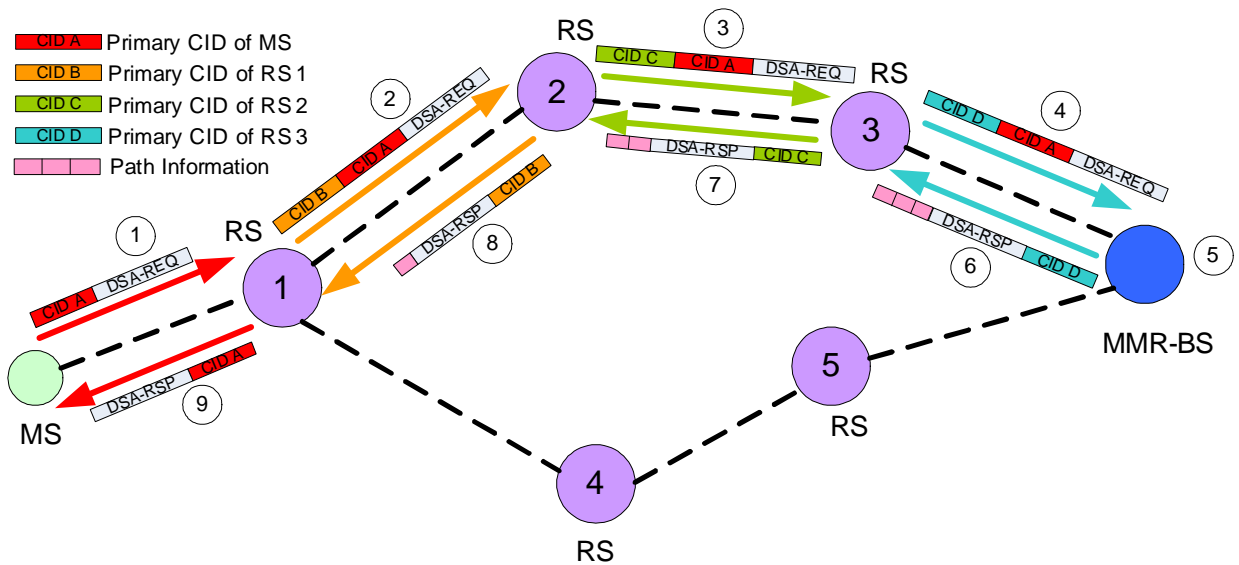

Fig.4 Path setup in MMR (CID mapping information piggyback in DSA-RSP)

- CID mapping information is piggybacked in DSA-RSP message

- Intermediate RS

b) CID mapping information sent standalone

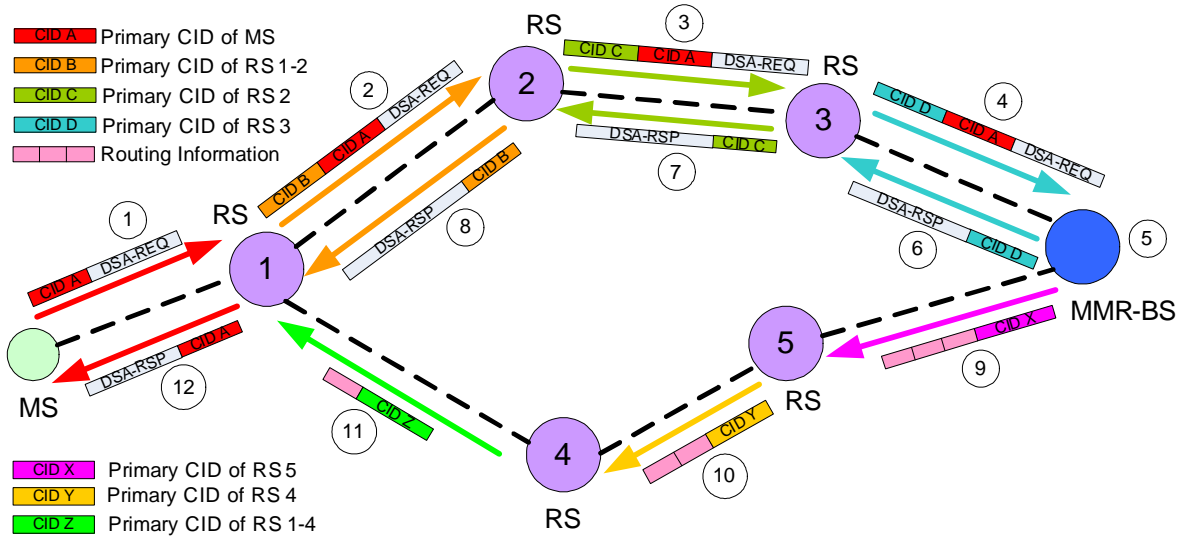
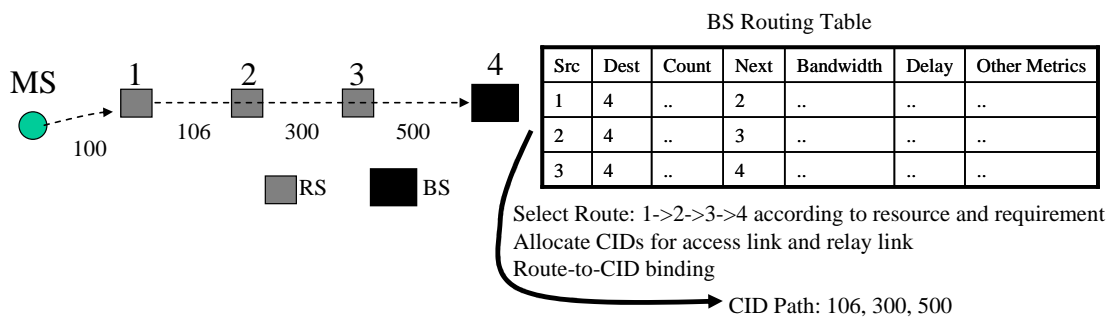

Fig.5 Path setup in MMR (CID mapping information sent standalone)

- The relay stations update their CID forwarding table according to the CID mapping information
- MS get a connection for the service and ready to carry the service on the connection.
- The relay stations can then relay the service by looking up its CID forwarding table

Figure 6 is the illustrated example of routing table and CID forwarding table after path is setup.

MR-BS uses the routing table to determine what RS(s) to relay the service, and RS uses the CID forwarding table to determine how to relay the service.



RS2 CID Forwarding Table

	In CID	Out CID	Action	Next Hop
From RS1	106	300	Mapping	RS3

RS1 CID Forwarding Table

	In CID	Out CID	Action	Next Hop
From MS	100	106	Mapping	RS2

Fig.6 example of routing table and CID forwarding table after path is setup

3 Text to be inserted into standard

-----Beginning of Text Changes-----

6.3.26 Relay path management procedures

[This section should contain the procedures to support relay path management and routing. The section should address issues such as,

Path setup/change/delete

CID mapping

The information that should be exchanged

]

Table of Contents

6.3.26.1 Connections and Path

6.3.26.2 Data path and control path

6.3.26.3 MAC PDU forwarding and CID mapping

- Encap
- Translate
- Decap

6.3.26.4 Control Path Management

6.3.26.5 Data Path Management

- Path setup
- Path change
- Path delete

6.3.26.6 Message Encodings

6.3.26.1 Connections and Path

In 802.16d/e, for communications between MS and BS, connections must be setup after initial ranging and network entry procedures. In MMR, for communications between MS/RS and MR-BS, path must be setup after initial ranging and network entry procedures. A path for a particular MAC PDU is a sequence of logical relay links $\langle L1, L2, \dots, Ln \rangle$, with the following properties:

1. $L1$ is a directional logical link between $RS1$ and $RS2$, where $RS1$ is access relay station for the communication between MS/RS and MR-BS.
2. For all i , $1 < i < n$, L_i is a directional logical link between intermediate relay stations $RS(i-1)$ and RS_i .
3. L_n is a directional logical link between intermediate relay stations RS_n and MR-BS.
4. For all i , $1 <= i <= n$, L_i is identified by one or multiple connection identifications (CIDs), which can be globally unique or locally unique to the logical link.

In other words, path for a particular MAC PDU can be regarded as the sequence of CIDs $\langle C1, C2, \dots, Cn \rangle$:

1. For all i , $1 <= i <= n$, C_i is the CID allocated to identify the logical relay link L_i .
2. For all i , $1 <= i <= n-1$, C_i and $C(i+1)$ can use same or different CID.
3. Different CIDs can be used to identify same logical relay link.

Corresponding to connection management in 802.16d/e, path management in MMR includes path setup, path change and path delete which can be triggered by DSA-REQ, DSC-REQ and DSD-REQ on the logical relay links L1~Ln on the path.

Path can be managed in MR-BS in centralized manner, or be optionally distributed but coordinated by the MR-BS.

6.3.26.2 Data path and control path

In MMR, control path is setup to exchange control/management information between a MS/RS and MR-BS. For example, at MS initialization, two pairs of management paths (uplink and downlink) shall be established between the access RS and the MR-BS and a third pair of management path may be optionally generated. The three pairs of management paths reflect the fact that there are inherently three different levels of QoS for management traffic between the MS/RS and MR-BS. The basic path is used by the MR-BS MAC and MS/RS MAC to exchange short, time-urgent MAC management messages. The primary management path is used by the MR-BS MAC and MS/RS MAC to exchange longer, more delay-tolerant MAC management messages. Finally, the secondary management path is used by the MR-BS and MS/RS to transfer delay tolerant, standard-based messages. The Use of the secondary management path is required only for managed MS/RS.

The CIDs for the logical link on these paths shall be assigned in the RND-RSP and REG-RSP messages. The same CID value is assigned to both members (uplink and downlink) of the logical link

In MMR, for the communications between MS/RS and MR-BS, the data path and the control path are different.

For bearer services, the MR-BS initiates the set-up of service flows paths (data paths) based upon the provisioning information distributed to the MR-BS. The registration of an MS/RS, or the modification of the services contracted at an MS/RS, stimulates the higher layers of the MR-BS to initiate the setup of the service flows paths. When admitted or active, service flows are uniquely associated with data paths. MAC management messages shall never be transferred over data paths. Bearer or data services shall never be transferred on the Basic, Primary, or Secondary Management paths.

6.3.26.3 MAC PDU forwarding and CID mapping by forwarding tables

In MMR, a path for a particular MAC PDU is the sequence of CIDs $\langle C1, C2, \dots, Cn \rangle$. When a MS/RS wants to exchange information with MR-BS,

1. It should send out the MAC PDU on the logical access link identified by CID C0.
2. Access relay station RS1 should then forward the MAC PDU on the logical relay link identified by CID C1.
3. Intermediate relay station RS_i ($1 < i < n$) should then forward the MAC PDU on the logical relay link identified by CID C_i.
4. Relay station RS_n should then forward the MAC PDU on the logical relay link identified by CID C_n to MR-BS.

The forwarding decision on the MAC PDU in a relay station in the path is based on the path information. The path information can be stored in the relay station, or optionally be got directly from the MAC PDU header. Consider a path P identified by a sequence of CIDs $\langle C1, C2, \dots, Cn \rangle$, the general forwarding process of the MAC PDU on the path P is such that:

1. Access relay station RS1 receives the MAC PDU that is sent out by MS/RS on the connection identified by CID C0. According to the CID C0 in the MAC PDU header, RS1 should takes corresponding actions on the PDU header such as stacking/replacing the CID C0 with C1. RS1 then send out the MAC PDU.

2. Intermediate relay station RS_i ($1 < i < n$) receives the MAC PDU that is sent out by $RS_{(i-1)}$ on the connection identified by CID $C_{(i-1)}$. According to the CID $C_{(i-1)}$ in the MAC PDU header, RS_i should takes corresponding actions on the PDU header such as replacing/stacking the CID $C_{(i-1)}$ with C_i . RS_i then sends out the MAC PDU.

3. Relay station RS_n receives the MAC PDU that is sent out by $RS_{(n-1)}$ on the connection identified by CID $C_{(n-1)}$. According to the CID $C_{(n-1)}$ in the MAC PDU header, $RS_{(n-1)}$ should takes corresponding actions on the PDU header such as replacing the CID $C_{(n-1)}$ with C_n . $RS_{(n-1)}$ then sends out the MAC PDU to MR-BS.

The corresponding actions a relay station would take on a particular MAC PDU are based on a mechanism known as CID mapping. CID mapping can be done in MR-BS in centralized mode or optionally be done in MR-BS and the relay station in distributed mode. By means of CID mapping mechanism, the relay stations would maintain a CID forwarding table which is used to forward MAC PDU. A CID forwarding table would be as follows:

Last Hop (Optional)	Ingress CID	Outgress CID	Action	Next Hop (Optional)
From RS1	20	30	Encap	RS3
From RS4	100	105	De-cap	RS5
From RS6	500	300	Translate	RS3

Table.2 CID Forwarding table

The ingress CID refers to the CID in the header of the incoming PDU. The outgress CID/CID list refers to the CID/CIDs in the header/path subheader of the outgoing PDU. To be versatile, one ingress CID can be mapped to one or multiple outgress CID/CID list to provide multi-path functionality, also multiple ingress CIDs can be mapped to one outgress CID/CID list to provide service merging functionality. In general, the CID forwarding table may allow mapping N ingress CIDs to M outgress CIDs/CID lists.

Actions encap/de-cap/translate are for cases that path information is stored in the relay station, and action header warp/stack/add list are for cases that path information is directly got from the MAC PDU header.

When a relay station receives a MAC PDU, it first reads in the CID from the PDU header and then lookup the CID forwarding table to take corresponding action as:

1. Encap

Relay station copies the CID (for example, 20) from the PDU header and appends to the head of the extended path subheader (if no path subheader, then creates one) of the PDU header. Relay station then replaces the CID 20 of the PDU header with the outgress CID (for example, 30). Relay station then takes accompanying actions such as setting extended subheader flag (ESF) and CRC re-calculation, it then sends out the MAC PDU on the connection CID 30.

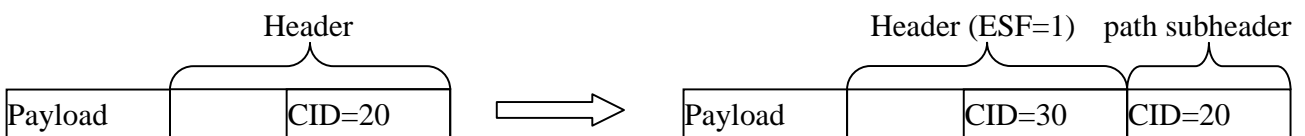

Fig.7 Encap Action

Typically, for cases that relay station stores path information, in uplink direction, the access relay station would take encap action to forward MAC Control PDU (such as those transmitted on basic/primary CID) from source MS/RS to intermediate relay station.

2. De-cap

Relay station replaces the CID (for example, 100) of the PDU header with the outgress CID (for example, 105). The outgress CID can be got from the head CID of the extended path subheader of the PDU header. Relay station then removes the head CID of the path subheader (if the head CID is the only CID, then also removes the path subheader and reset ESF=0). Relay station then takes accompanying actions such as CRC re-calculation and sends out the MAC PDU on the connection CID 105.

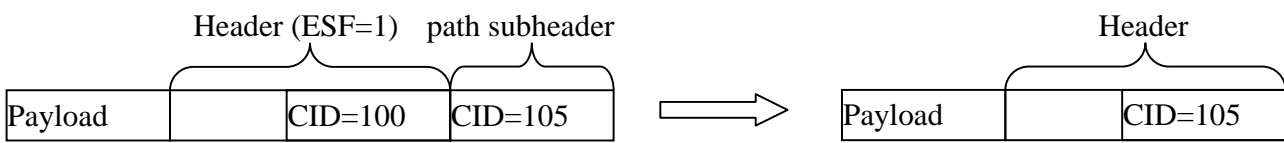

Fig.8 De-cap Action

Typically, for cases that relay station stores path information, in downlink direction, the access relay station would take de-cap action to forward MAC Control PDU (such as those transmitted on basic/primary CID) from intermediate relay station to target MS/RS.

3. Translate

Relay station replaces the CID (for example, 500) of the PDU header with the outgress CID (for example, 300). Relay station then takes accompanying actions such as CRC re-calculation and sends out the MAC PDU on the connection CID 300.

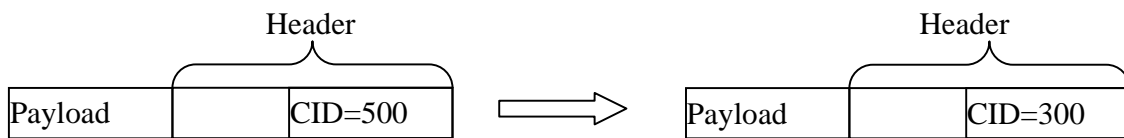

Fig.9 Translate Action

Typically, for cases that relay station stores path information, in downlink/uplink direction, the relay stations on the path would take translate action to forward MAC Data PDU. The intermediate stations on the path would also take translate action to forward MAC Control PDU (such as those transmitted on basic/primary CID). Indeed, it would be the most common one that a relay station would take to relay MAC PDU.

6.3.26.4 MAC PDU forwarding and CID mapping by subheader path lists

The kind of forwarding is determined by the type of subheader. If the type field in the received MAC PDU contains path list type, header warp has to be used to perform forwarding. An intermediate RS has to perform only header warp, an access RS has to perform additionally subheader removal on downlink and subheader insertion on uplink direction. If the type field contains header stack type, the RS has to perform header stack processing.

6.3.26.4.1 Header Warp

In downlink direction relay station copies the CID (for example, 200) from the PDU header and appends to the tail of the extended path subheader. Relay station then replaces the CID (for example 200) of the PDU header with the head CID (for example, 301) of the extended path subheader. Relay station then takes accompanying actions such as CRC re-calculation, subheader IE's update and sends out the MAC PDU on the connection CID 301. In uplink direction the same mechanism is used in reversed order. Relay station copies the CID (for example, 200) from the PDU header and prepends at begin of the extended path subheader. Relay station then replaces the CID (for example 200) of the PDU header with the tail CID (for example, 301) of the extended path subheader.

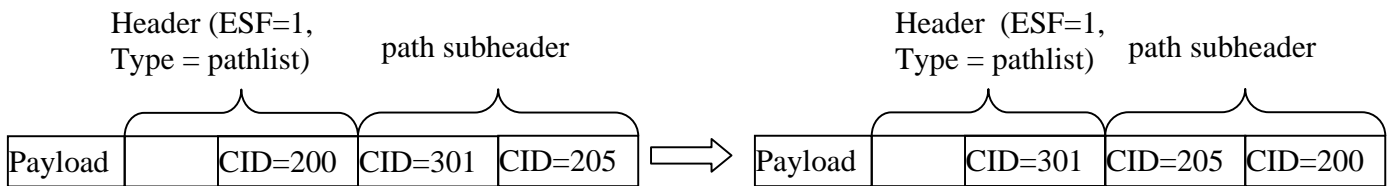

Fig.10 Header Warp Action

Typically, for cases that MAC PDU itself carries path information, in downlink/uplink direction, intermediate relay stations on the path can take header warp action to forward MAC PDU. In such cases, intermediate relay stations do not need to store/maintain path information. Access relay stations may store path information from received management PDU's in downlink direction and use this information for setup uplink path information. According to the information in the subheader, a MR-BS can determine the originator of a management MAC PDU. The last CID in the CID list is the management CID of the originator.

6.3.26.4.2. Header Stack

Relay station replaces the CID (for example, 80) from the PDU header with the head CID (for example, 90) of the extended path subheader. Relay station then removes the head CID of the path subheader (if the head CID is the only CID, then also removes the path subheader and reset ESF=0). Relay station then takes accompanying actions such as CRC re-calculation and sends out the MAC PDU on the connection CID 90.

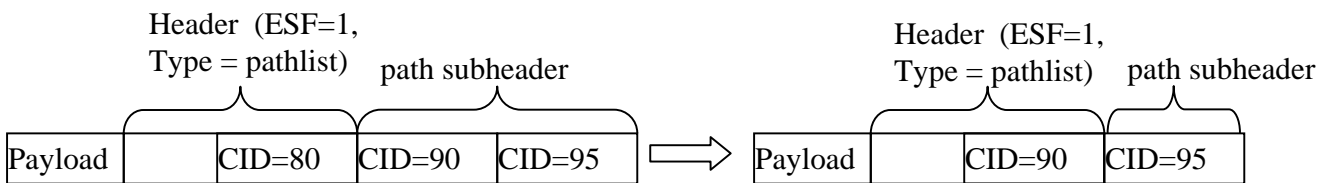

Fig.11 Header Stack Action

Typically, for cases that MAC PDU itself carries path information, in downlink/uplink direction, intermediate relay stations on the path can take header stack action to forward MAC PDU. In such cases, intermediate relay stations do not need to store/maintain path information. Obviously, the header stack mode would be more bandwidth-efficient than the header warp mode.

6.3.26.4.3. Add List

Relay station replaces the CID (for example, 220) from the PDU header with the head CID (for example, 230) of the corresponding CID list and appends the list to the head of the extended path subheader (if no path subheader, then creates one). Relay station then takes accompanying actions such as CRC re-calculation and sends out the MAC PDU on the connection CID 230.



Fig.12 Add List Action

Typically, for cases that MAC PDU itself carries path information, the access relay stations would take add list action to forward MAC PDU. In such cases, the access relay stations need to store/maintain path information.

The CID forwarding table shown in table 2 is maintained through path management procedures. Corresponding to the management of control and data connection, there are path managements for control and data path in MMR.

6.3.26.5 Control Path Management
TBD

6.3.26.6 Data Path Management

6.3.26.6.1 Path setup

Refer to figure 13 for the path setup for MS (similar procedure for the path setup for RS)

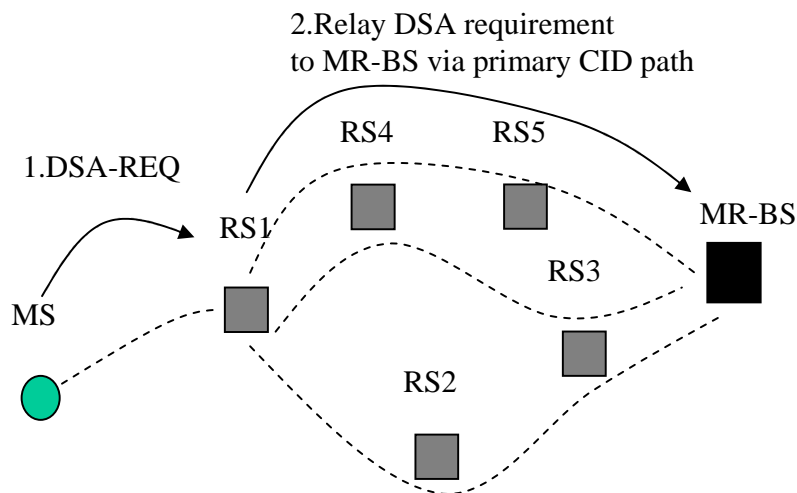

Fig.13 Data Path Setup

In MMR, after initial ranging and network entry procedures, MS shall get a primary CID. MS can then request for a service connection for the service communication between it and MR-BS.

Referring to figure 13, the procedure can be divided into the following phases:

- 1) Request
 - a) MS send DSA-REQ to the access relay station RS1 using MS's primary CID

- b) RS1 would relay the MS's DSA-REQ to MR-BS using RS1's owning primary CID
 - Typically, RS1 would take encap action to relay the MS's DSA-REQ
- c) Intermediate relay station RS4 and RS5 would relay the information carried via RS1's primary CID to MR-BS using their own primary CID
 - Typically, intermediate RS would take translate action to relay the information carried via last hop RS's primary CID
- d) MR-BS would get the MS's DSA-REQ
 - Typically, MR-BS would take de-cap action to get the MS's DSA-REQ

2) DSA-REQ Processing in MR-BS

After MR-BS get the DSA-REQ message from MS, the MR-BS would:

- a) Choose a data path for the MS's service requirement carried in DSA-REQ. (This data path selected can be different from that selected for the MS's primary CID path to MR-BS). The data path selection is the result of service admission and resource allocation.
- b) Allocate CIDs and bind it with selected route for the service, and also,
- c) Allocate the corresponding resources for the allocated CIDs (one for MS's requested service, others for the relaying RSs to relay the MS's service)
 - If multi-path routing or cooperative relay are to be implemented, RS in the selected data path may be allocated more than one CIDs for the MS's currently requested service
- a) Update its information base to reflect the procedures above.
- b) MR-BS then send DSA-RSP and CID mapping information to RS
 - MR-BS would take encap action to send DSA-RSP via primary CID
 - CID mapping information could be sent via either:
 - Piggyback in DSA-RSP: DSA RSP would then include: CID for MS, CID(s) and action(s) for RS to relay the service, and optionally corresponding last/next hops for the service in RS.
 - Or separate CID mapping message (new message to be defined for MMR). CID mapping messages would then include: CID for MS, CID(s) and action(s) for RS to relay the service, and optionally corresponding last/next hops for the service in RS.
 - To facilitate the CID mapping, the uplink CID mapping information may also include downlink CID mapping info

3) Respond

The MR-BS should respond with DSA-RSP message and CID mapping information. The CID mapping information could be piggybacked in DSA-RSP message or optionally sent separately.

- a) CID mapping information piggybacked in DSA-RSP

Refer to figure 14,

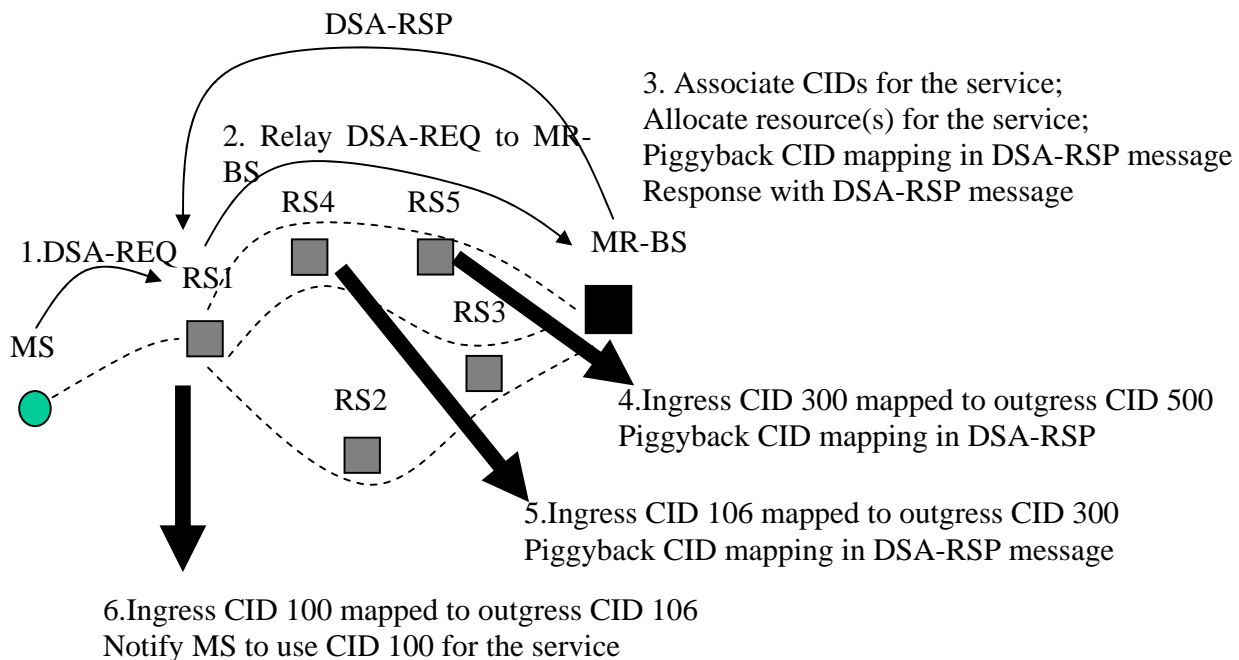

When RS1 get DSA-RSP, it can notify MS to use CID 100 via DSA-RSP,

Fig.15 CID mapping information piggybacked in DSA-RSP

- Relay stations RS5 and RS4 parse the DSA-RSP and relay it next hop
 - Typically, RS5 and RS4 would take translate action to relay the DSA-RSP
 - RS5 and RS4 can optionally delete redundant information such as last hop CID from the DSA-RSP for bandwidth efficiency
 - IF path information is to be stored in relay stations, RS5 and RS4 would update their CID forwarding table to reflect the corresponding CID mapping information for the service.
- RS1 parses the DSA-RSP, and notify the MS to use corresponding CID via DSA-RSP sent on MS's primary CID
 - Typically, RS1 would take de-cap action to relay the DSA-RSP to MS
 - The DSA-RSP message sent by RS1 to MS is 802.16e standard DSA-RSP which should not include CID mapping information. MS should use the CID contained in the DSA-RSP to carry the service.
 - RS1 would update their CID forwarding table to reflect the corresponding CID mapping information for the service.
- RS1 can then send DSA-ACK to MR-BS to confirm the DSA-RSP

b) CID mapping information sent separately

Refer to figure 16,

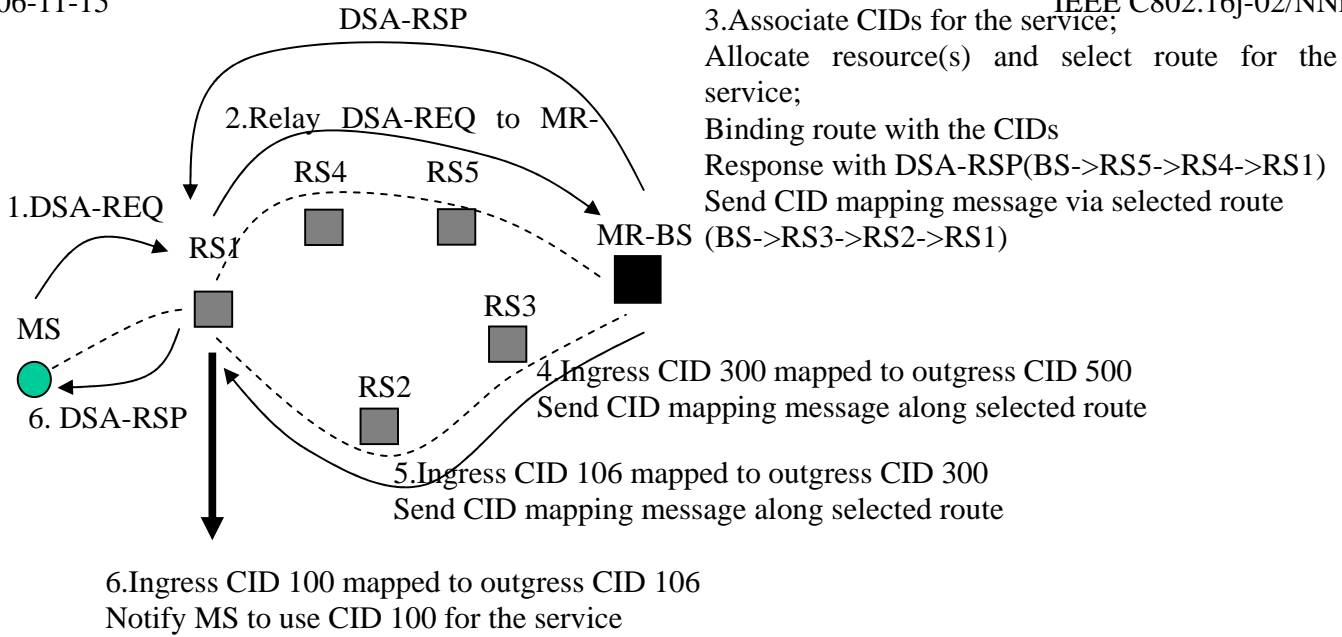

When RS1 get CID mapping and DSA-RSP, it can notify MS to use CID 100 via DSA-RSP
And the data path is: RS1->RS2->RS3->BS

Fig. 16 CID mapping information sent separately

- The MR-BS sends the DSA-RSP message via the primary CID to RS5. Also, the MR-BS sends out the CID mapping message.
 - Typically, the CID mapping message is sent on the primary CID
 - Optionally, the CID mapping message could be sent on other control CID such as secondary CID.
- Intermediate relay stations RS5 and RS4 parse/relay the DSA-RSP message via the primary CID to next hop. Intermediate relay stations parse/relay the CID mapping message to next hop.
 - Typically, the CID mapping message is sent on the primary CID.
 - Optionally, the CID mapping message could be sent on other control CID such as secondary CID.
- RS1 parses the DSA-RSP, and only when it also get CID mapping information for the MS, should it notify the MS to use corresponding CID via DSA-RSP via MS's primary CID
 - The DSA-RSP sent by ARS should not contain CID Mapping info.

4) Acknowledge

After MS got the DSA-RSP message from access relay station RS1, the MS would send DSA-ACK message on the primary CID to acknowledge the message.

- Relay station in the path would process/relay the DSA-ACK to the MR-BS (similar to the procedure above for the DSA-REQ message)

After these stages, the MS can then use the CID contained in DSA-RSP message to carry the service.

6.3.26.6.2 Path change

6.3.26.6.3 Path delete
TBD

6.3.26.7 Management PDU forwarding by subheader path list

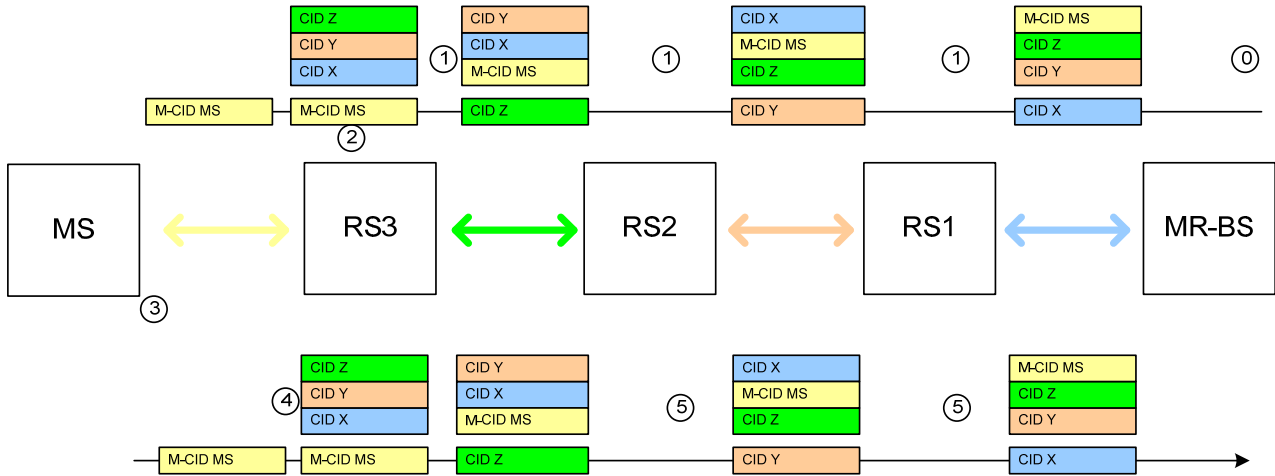

Fig.17 Example: Management PDU Forwarding, MR-BS to MS via 3 RS

After network entry of MS, MR-BS sends a first MAC management message to MS using a management CID of MS

0: MR-BS prepare MAC PDU with CID list in subheader according to its topology database

1: RS performs CID list wrap around for downlink (as described in 6.3.26.4.1)

2: RS3 stores stack, removes subheader to get an 802.16 compliant MAC PDU, and sends it to MS

3: MS sends reply MAC management message using its management CID

4: RS3 receives MAC PDU, perform a lookup in its stored CID list database, (using M-CIS MS as an index), builds subheader, perform an uplink wrap around and sends MAC PDU to next hop

5: RS performs CID list wrap around for uplink (as described in 6.3.26.4.1)

MR-BS may use last CID entri in subheader list for determining the originator of the PDU

6.3.26.8 Message encodings

If CID mapping information is sent standalone, then add the columns into Table 14 as indicated

Table 14—MAC Management messages

Type	Message Name	Message description	Connection
80	CID_MAP	CID mapping message	Basic

The format of the CID mapping message (CID_MAP) is depicted in Table 3

Table 3—CI_MAP message format

Syntax	Size	Notes
CID_MAP_Message_format(){	--	CID mapping message
Management Message Type=80	8 bits	--
N_RS	4 bits	Number of RS to relay the service
For(j=0; j<N_RS; j++){	--	--
RS ID	24 bits	Identify RS
Action	3 bits	Indicate RS how to relay the ingress CID 000: CID Translate 001: CID Encap 010: CID Decap 011: Reserved 100: CID Header Wrap 101: CID Header Stack 110: CID Header Add List 111: Reserved
Outgress CID	16 bits	CID that to be put into the header of MAC PDU which is carried on the ingress CID. Only for action 000, 001.
}		
TLV encoded information	variable	--
Padding	variable	If needed for alignment to byte boundary
}		

If CID mapping information is piggyback in DSA-RSP message, then add Table 383 as indicated

Table 383---Service flow encodings

Type	Parameter
47	CID mapping information

Insert the new subclause 11.13.38:

11.13.38 CID mapping information

Type	Length	Value	Scope
[145/146].47	variable: 6n	Compound: For(j=0; j<N_RS; j++){ 24bits: RS_ID 8bits: Action 16bits: OutgressCID } Action: Indicate RS how to relay the ingress CID 0x00: CID Translate 0x01: CID Encap	DSx-REQ DSx-RSP DSx-ACK

		0x02: CID Decap 0x03: Reserved 0x04: CID Header Wrap 0x05: CID Header Stack 0x06: CID Header Add List 0x07~0xFF: Reserved	
--	--	--	--

[Reference]

[1] IEEE C80216j-06/017, July 2006

[2] IEEE 80216e-2005, Feb. 2006

[3] IEEE C80216j-06_101r1, Sep. 2006